

MOTORSCHUTZPLATTE / SKID PLATE

BMW F 900 GS (2024-)

Art.Nr./Item-no.:

8106534 00 01 schwarz/black

8106534 00 12 alu gebürstet/alu brushed

BMW F 900 GS Adventure (2024-)

Art.Nr./Item-no.:

8106535 00 01 schwarz/black

8106535 00 12 alu gebürstet/alu brushed



BMW F 800 GS (2024-)

Art.Nr./Item-no.:

8106537 00 01 schwarz/black

8106537 00 12 alu gebürstet/alu brushed

Inhalt

1x 700013847 Motorschutzplatte alu
ODER

1x 700013848 Motorschutzplatte schwarz

1x 700010225 Halter hinten

1x 700010227 Halter vorne

1x 700013849 Schraubensatz:

- 2 Zylinderschraube M6x35
- 2 Zylinderschraube M8x45
- 2 Zylinderschraube M6x50
- 1 Zylinderschraube M8x16
- 6 Zylinderschraube M6x25
- 4 U-Scheibe Ø8,4
- 10 Karosseriescheibe Ø6,4xØ18
- 2 Aludistanz Ø15xØ9x30
- 2 Aludistanz Ø18xØ9x25
- 2 Aludistanz Ø13xØ7x16
- 6 M25067 Gummitülle M6 mit Buchse

Content

1x 700013847 Skid plate alu
OR

1x 700013848 Skid plate black

1x 700010225 Holder rear

1x 700010227 Holder front

1x 700013849 Screw kit:

- 2 Allen screw M6x35
- 2 Allen screw M8x45
- 2 Allen screw M6x50
- 1 Allen screw M8x16
- 6 Allen screw M6x25
- 4 Washer Ø8,4
- 10 Body washer Ø6,4xØ18
- 2 Alu spacer Ø15xØ9x30
- 2 Alu spacer Ø18xØ9x25
- 2 Alu spacer Ø13xØ7x16
- 6 M25067 Rubber grommet M6 with bushing



120424/240424/090724/190724

Wichtig / Important:

Beachten Sie die in Ihrem Land geltenden Zulassungsbestimmungen.

Für den Bereich der BRD gilt: Ein Eintrag in die Fahrzeugpapiere ist nicht erforderlich.

Wir empfehlen, die Montage in einer Fachwerkstatt durchführen zu lassen. Bei der Montage, alle zugänglichen Schrauben vorerst nur locker andrehen, sodass eine spannungsfreie Montage gewährleistet wird. Beim Anziehen der Schrauben, Anzugsmomente beachten.

We recommend having the installation carried out in a professional workshop. During installation, tighten all accessible screws loosely at first to ensure tension-free installation. When tightening the screws, observe the tightening torques.

Benötigte Werkzeuge / Required tools

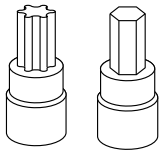

Set

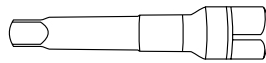

Verlängerung/extension

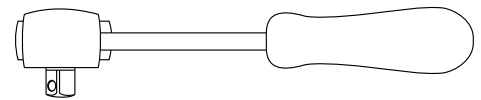

Ratsche/Ratchet

Vorbereitende Maßnahmen / Preparatory actions

Den originalen Motorschutz und dessen beiden Halterungen demontieren, alle Teile entfallen.

Remove the original skid plate and its two brackets, all parts are no longer required.

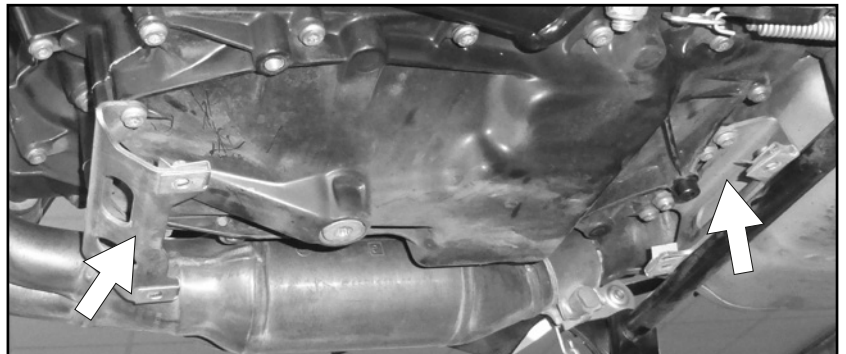

Die Gummitüllen M6 in die Bohrungen der Vertiefungen einsetzen.

Darauf achten, dass die Bundhülse von der Innenseite der Motorschutzplatte eingesetzt wird.

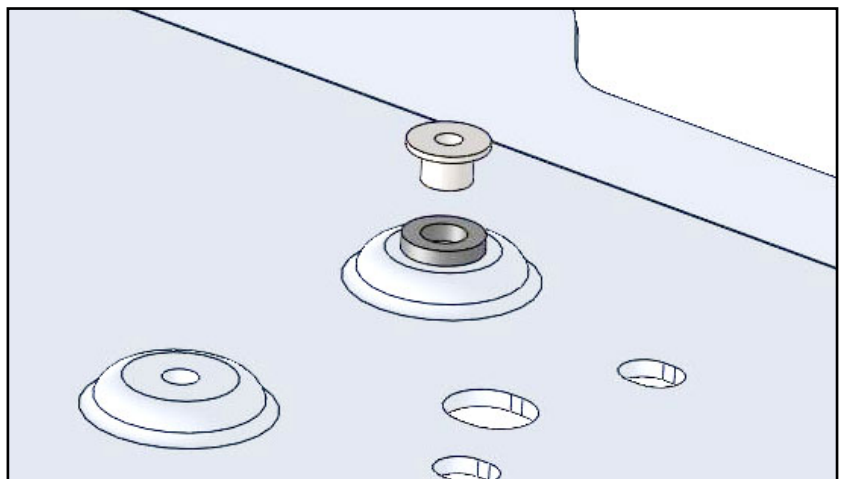

Insert the M6 rubber grommets into the holes in the recesses.

Ensure that the collar sleeve is inserted from the inside of the skid plate.



Montageanleitung / Installation Instruction

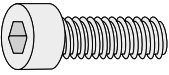
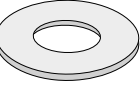
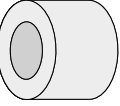
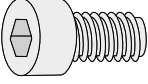

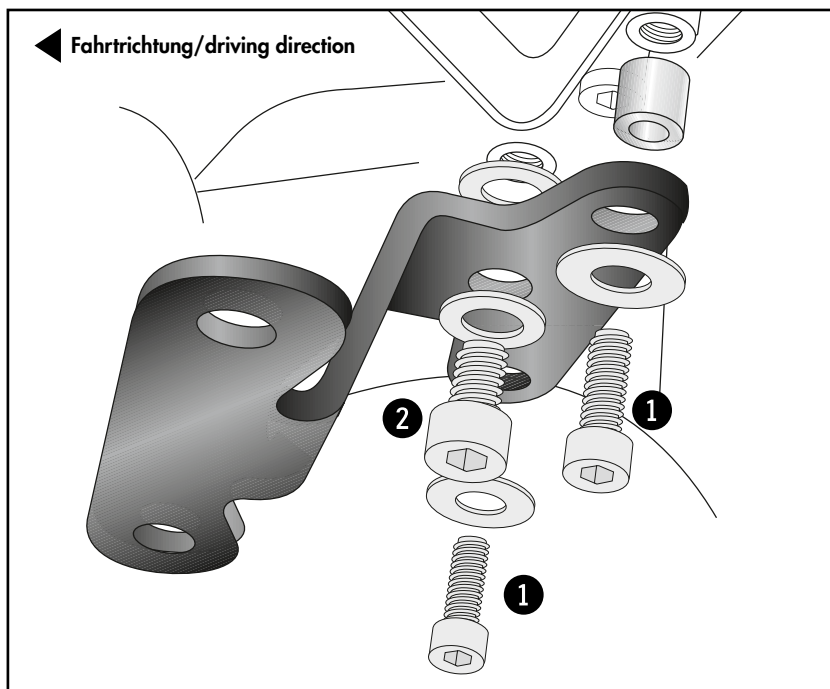

Montage des hinteren Halters: Fastening of the rear holder:

- 2x**  **1** M6x35
- 2x**  Ø6,4x18
- 2x**  Ø13xØ7x16
- 1x**  **2** M8x16
- 2x**  Ø8,4

1

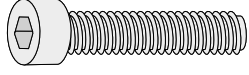
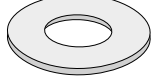

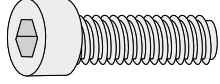
Montage des vorderen Halters: Fastening of the front adapter:

- Vorne/Front** **1**
- 2x**  M6x50
- 2x**  Ø6,4x18
- 2x**  Ø15xØ9x30
- Hinten/Rear** **2**
- 2x**  M8x45
- 2x**  Ø8,4
- 2x**  Ø18xØ9x25

2

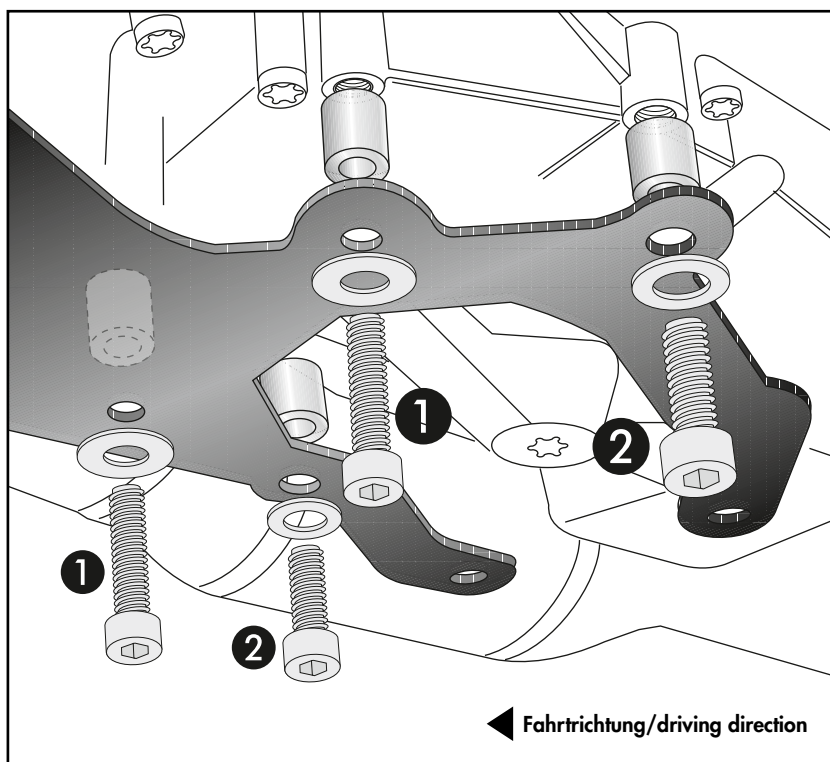

Montageanleitung / Installation Instruction

Montage der Motorschutzplatte rechts/links:
Fastening of the skid plate right/left:

3

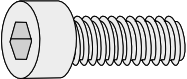
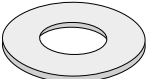
- 6x  M6x25
- 6x  Ø6,4x18

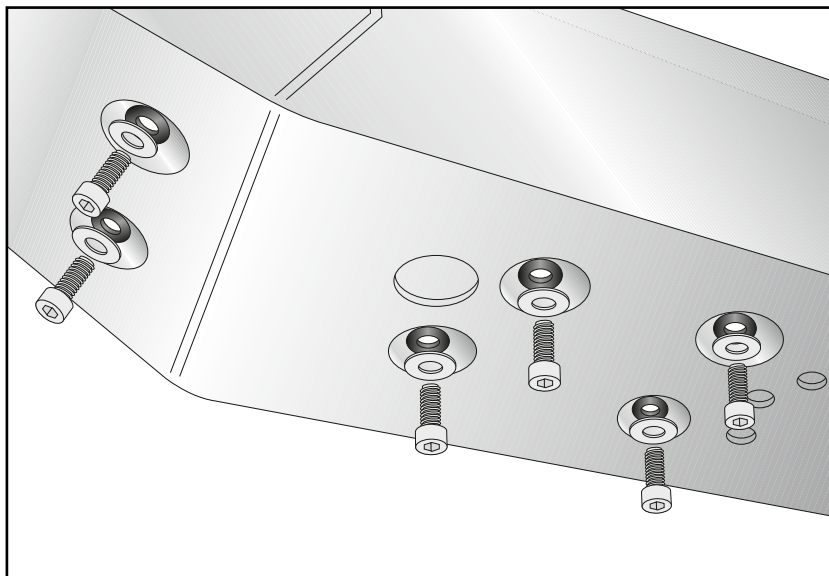

Achtung / Attention:

Nach der Montage alle Verschraubungen auf festen Sitz kontrollieren! Abgebaute Teile wieder montieren. Bitte beachten Sie unsere beigefügten Serviceinformationen.

Control all screw connections after the assembling for tightness! Reassemble the dismantled parts. Please notice our enclosed service information.

Weiteres Zubehör für dieses Modell auf www.hepco-becker.de / More accessories for this model see www.hepco-becker.de

HEPCO&BECKER GmbH | An der Steinmauer 6 | 66955 Pirmasens | Germany | Tel. +49 6331 1453100 | Fax: +49 6331 1453 120 | Mail: vertrieb@hepco-becker.de

HEPCO&BECKER

8106534 00 01 / 8106534 00 12 / 8106535 00 01 / 8106535 00 12

4